



INVENT UACH
INNOVATIVE ENERGY TECHNOLOGIES



Hydrogen Initiatives

Innovative Energy Technologies Center INVENT UACH

<https://www.inventuach.cl/>

IECO Days 2021
October 5th, 2021



Universidad Austral de Chile
Facultad de Ciencias Agrarias y Alimentarias



INVENT UACH

INNOVATIVE ENERGY TECHNOLOGIES



Universidad Austral de Chile
Campus Patagonia



FACULTAD
ARQUITECTURA Y ARTES
Universidad Austral de Chile

Energy Storage and Conversion Devices



Energy Efficiency and Clean Heating Systems

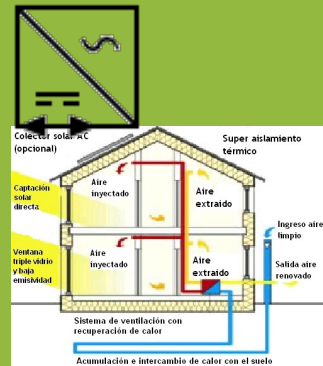
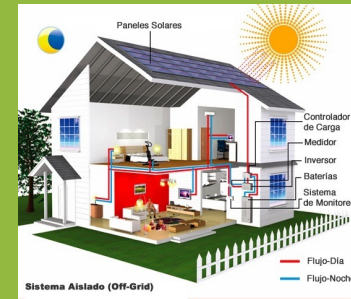
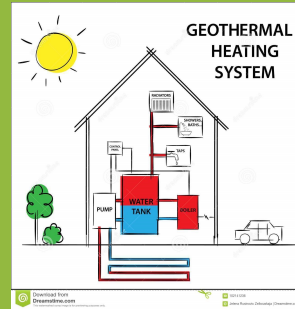

Smart Farming and Sensor Technology



H2V PFA MOWI

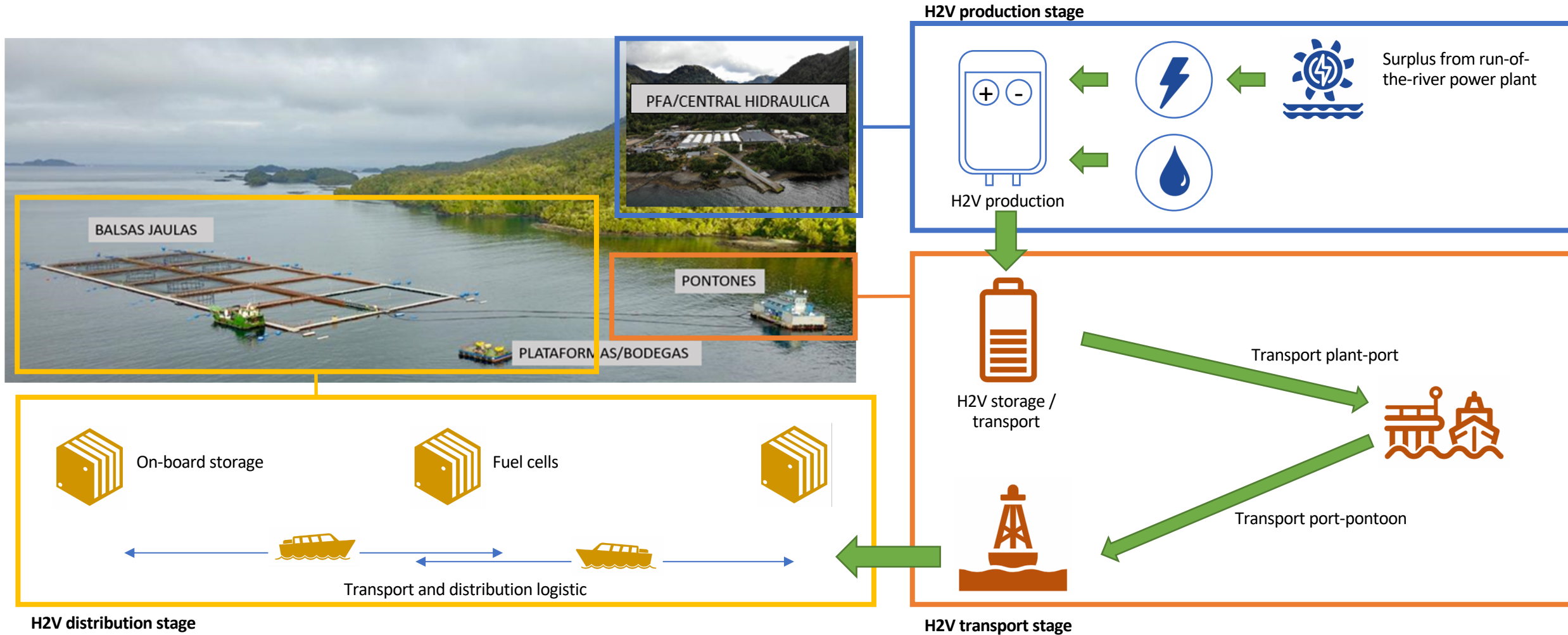

MULTI-ENERGY DISTRIBUTED SYSTEMS

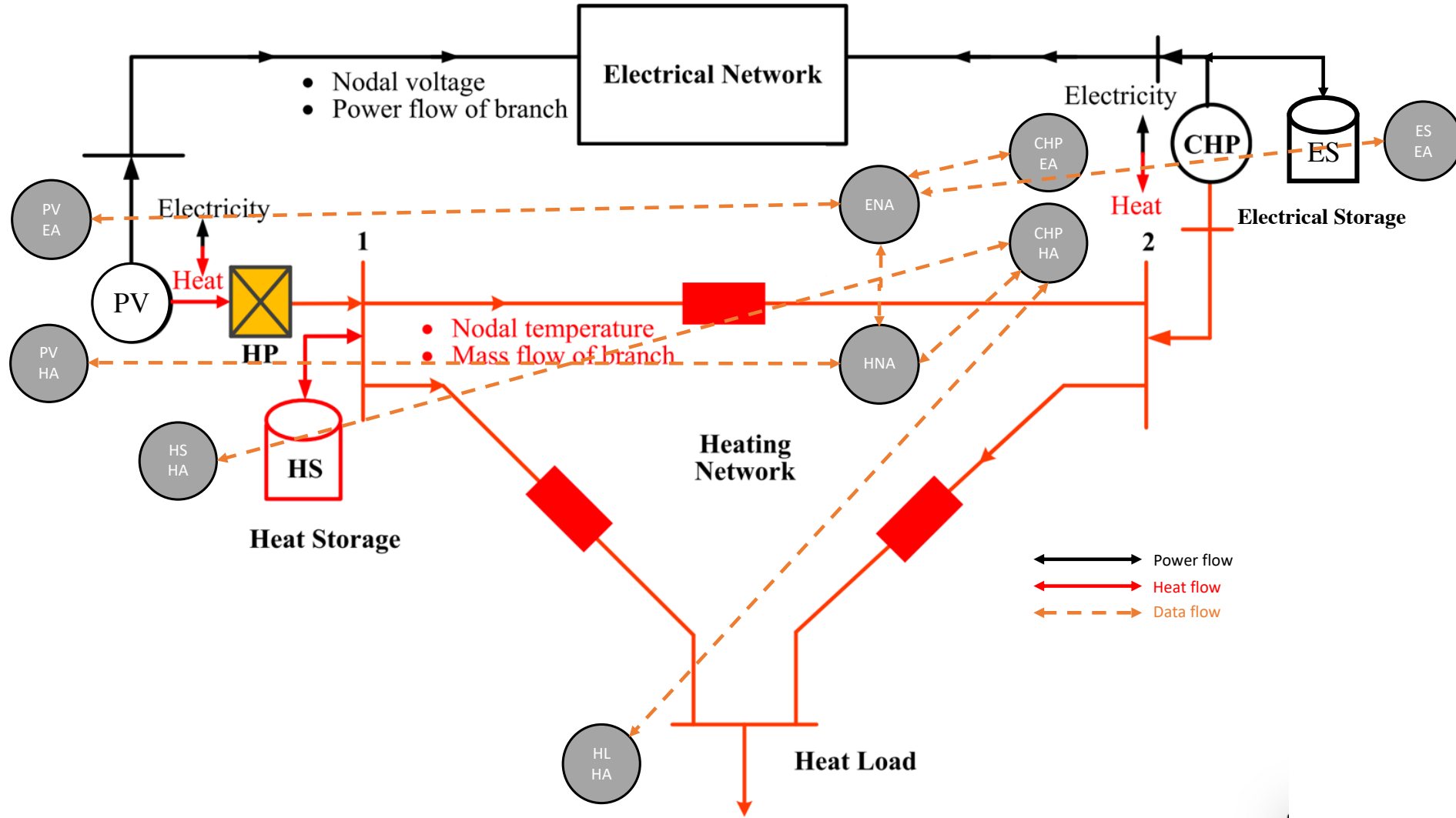

INDUSTRIAL HYBRID SHIP PROTOTYPE

SISTEMA PROPULSIÓN ELÉCTRICO eDIÉSEL/ H2V

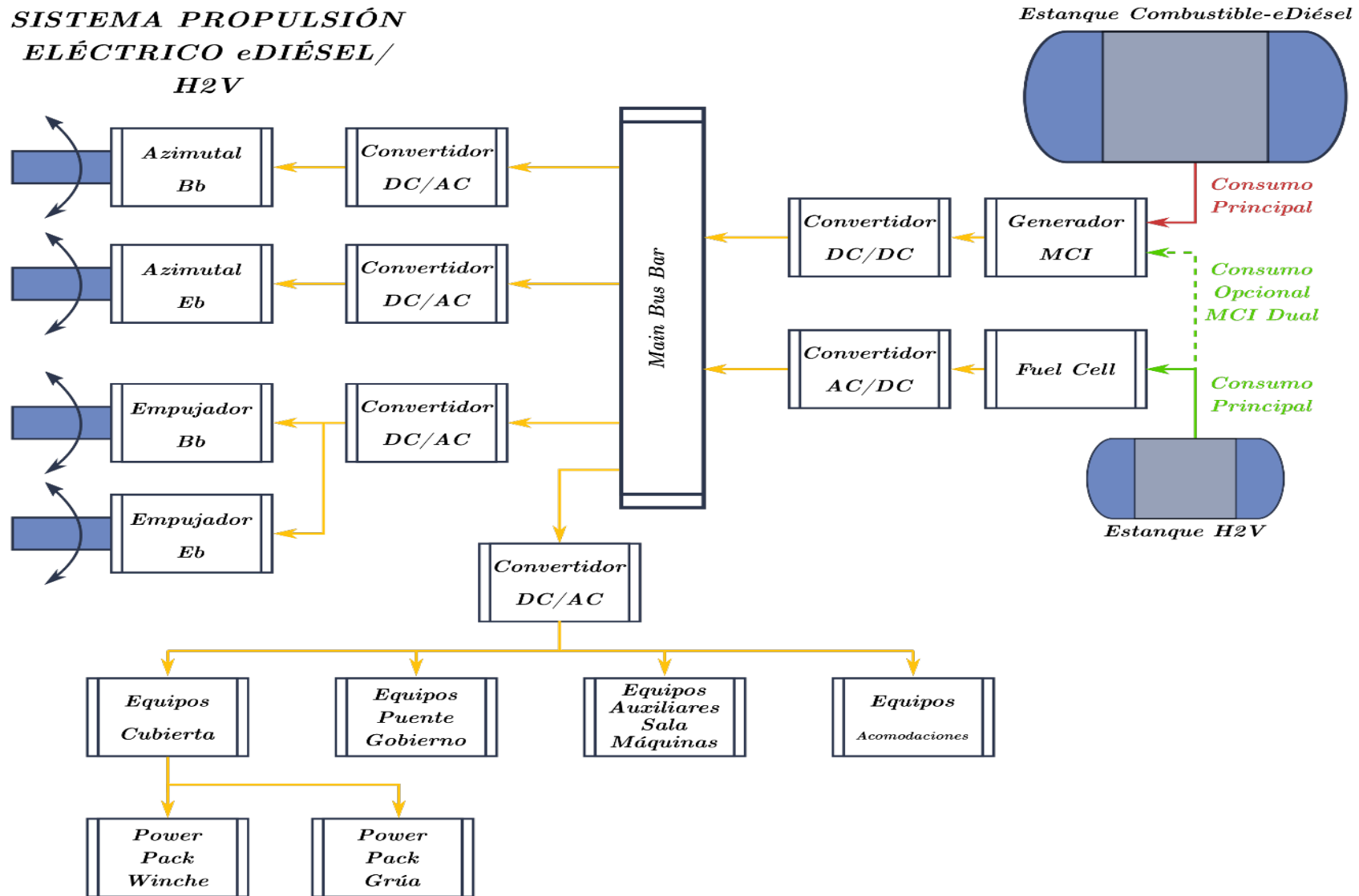

SMALL-SCALE HYBRID SHIP PROTOTYPE

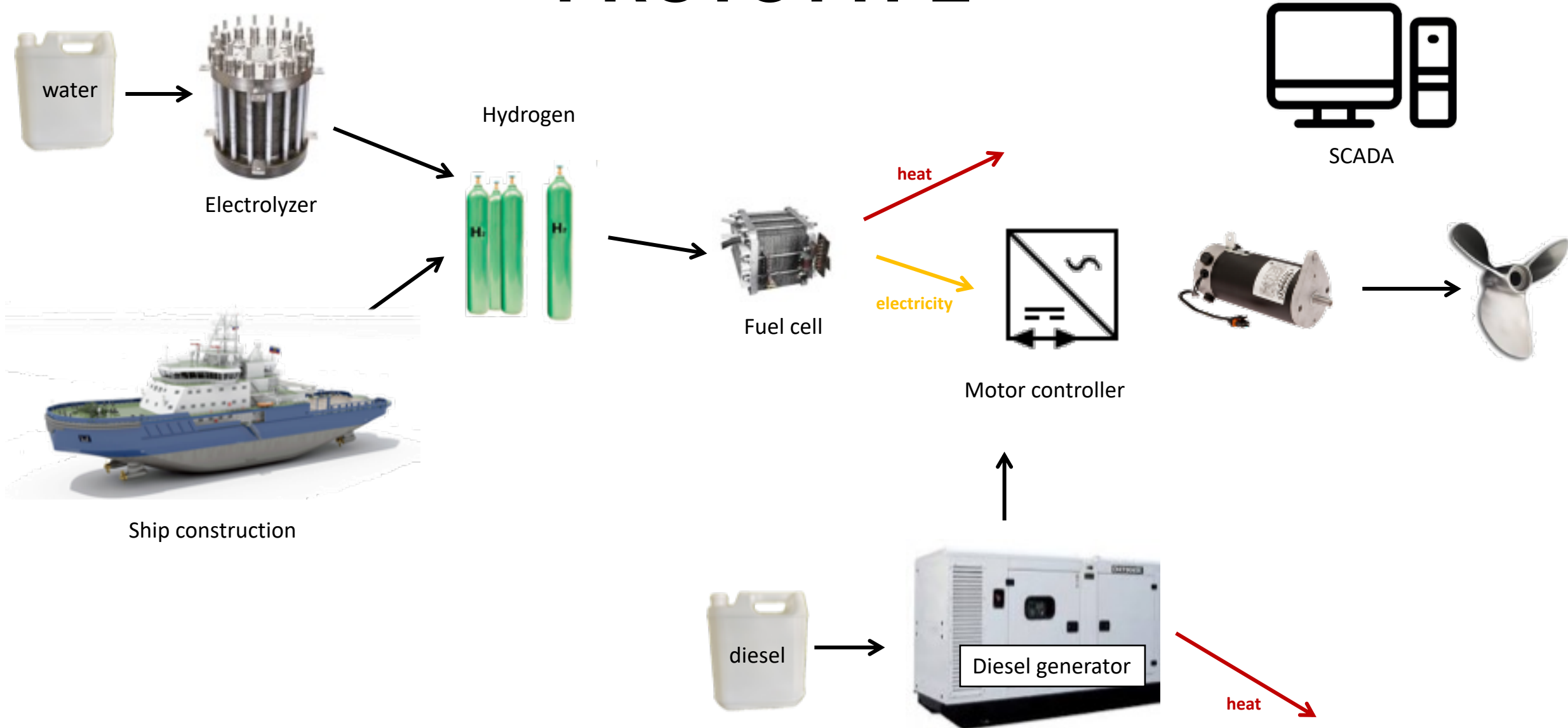

Campus Smart Grid

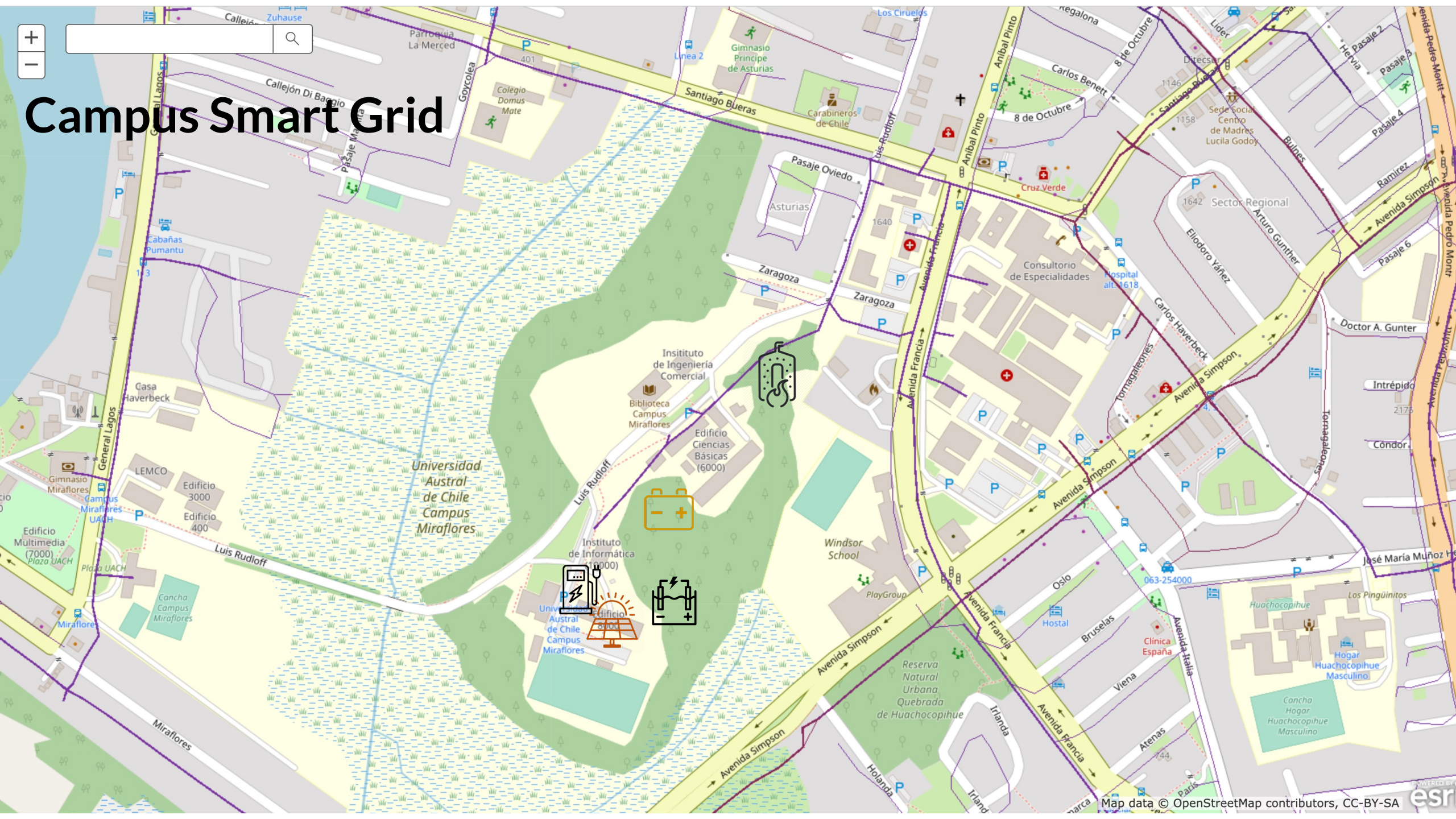

Innovative Energy Technologies Center INVENT UACH

Universidad Austral de Chile



<https://www.inventuach.cl/>

Universidad Austral de Chile
Facultad de Ciencias de la Ingeniería
Ed. 6000 Eduardo Contreras Villa